

ISA-PLAN® - SMD precision resistors

TECHNICAL DATA	
Resistance values	3 mOhm - 2 Ohm
Tolerance	0.5 %*, 1 %, 5 %
Temperature coefficient	< 50 ppm/K (20 °C - 60 °C)
Applicable temperature range	-55 °C to +170 °C
Load capacity	3 W
Internal heat resistance (R_{thi})	20 K/W
Dielectric withstanding voltage	200 V AC/DC
Inductance	< 3 nH
Stability (Nominal load) deviation T_K = Terminal temperature	< 0.5 % after 2000 h (T_K = 80 °C) < 1.0 % after 2000 h (T_K = 110 °C)

* Upon request

FEATURES

- 3 W permanent power at 110 °C
- Constant current up to 30 A (3 mOhm)
- High pulse power rating
- Excellent long term stability
- Mounting: Reflow- and IR-soldering
- AEC-Q200 qualified

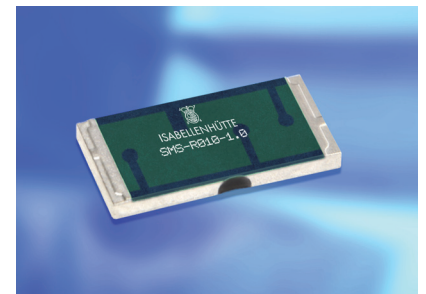

Size 2512

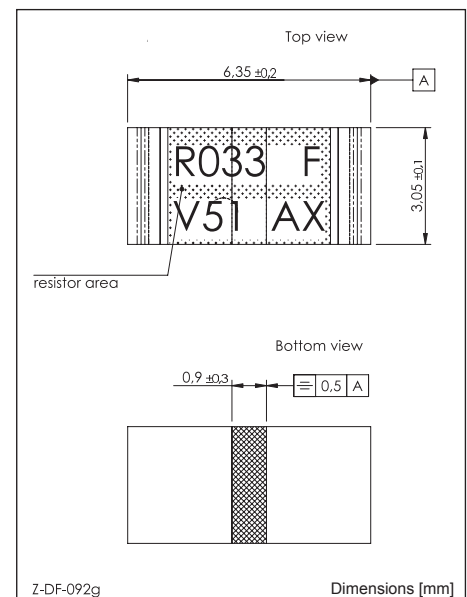

APPLICATION

- Current sensor for power hybrid applications
- Control systems for the automotive market
- Power modules
- Frequency converters
- Switch mode power supplies

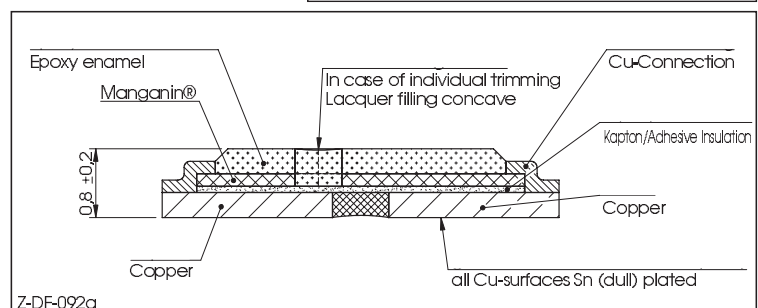

TCR, power derating and long term stability

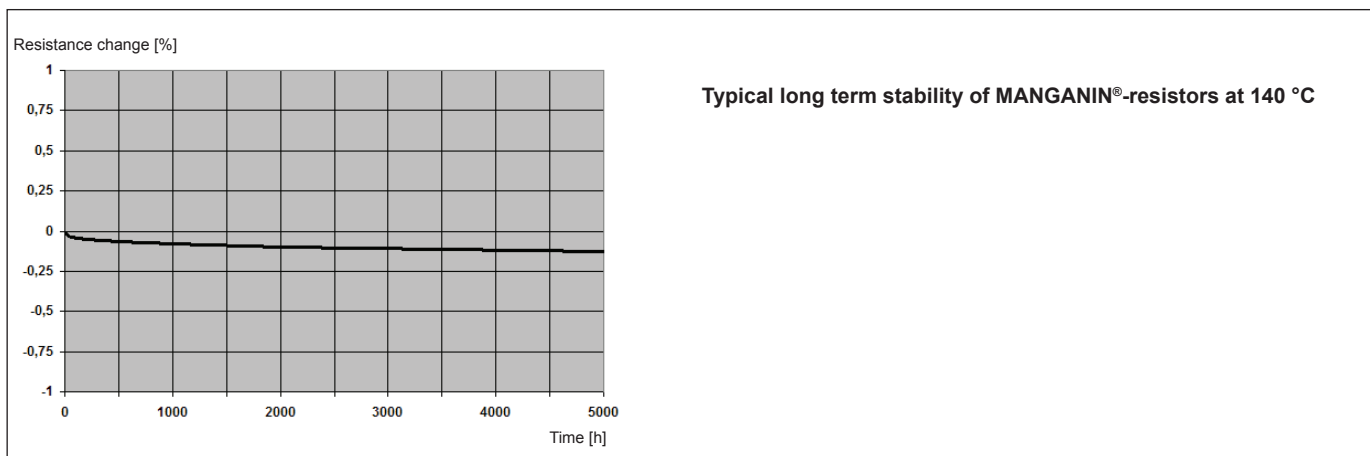
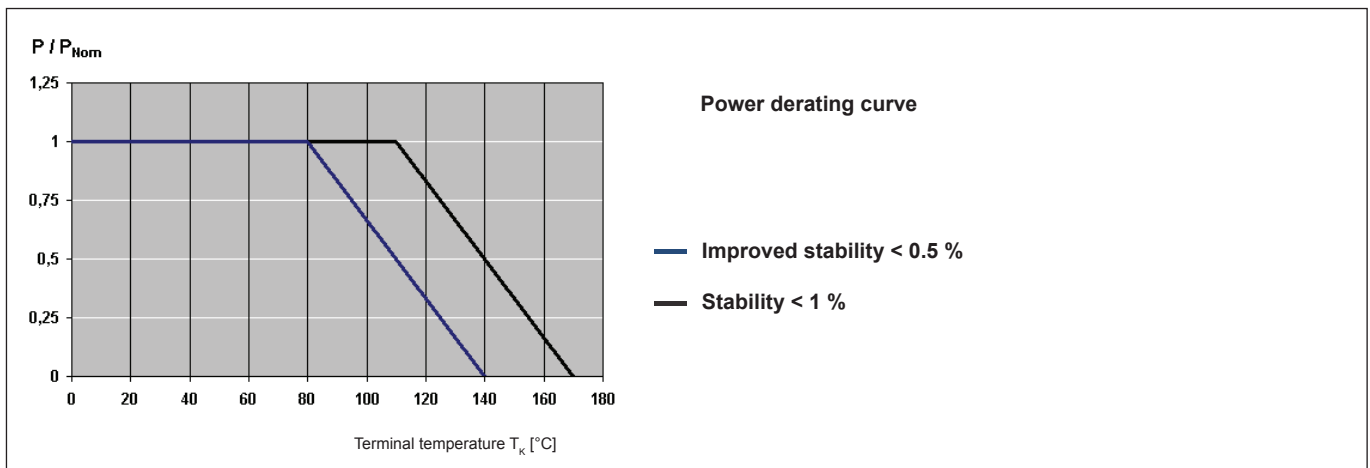
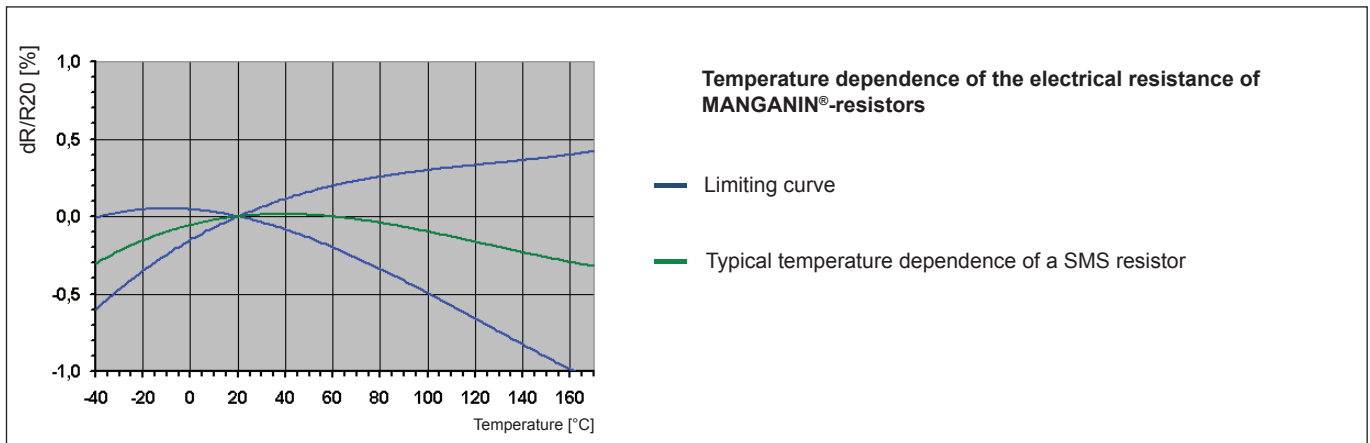

Proposal for pcb-layout (Reflow-soldering)

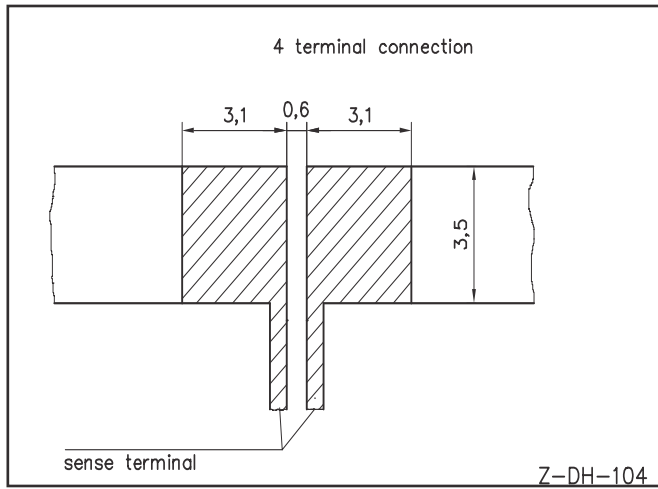

Dimensions [mm]

Recommended solder profile

Reflow-, IR-soldering

Temperature [°C]	260	255	217
Time [s]	peak	40	90

RoHS 2002/95/EC compliance since product launch.

 For more information please visit our website:
www.isabellenhuette.de

Slight deformations during soldering do not affect technical properties of the component.

TAPE & REEL INFORMATION

Specification	DIN EN 60286-3
Tape width	12 mm
Parts per reel	5,000 pcs.

ORDERING CODE

SMS-R005-1.0

Type	Resistance value	Tolerance
SMS	5 mOhm	1.0 %

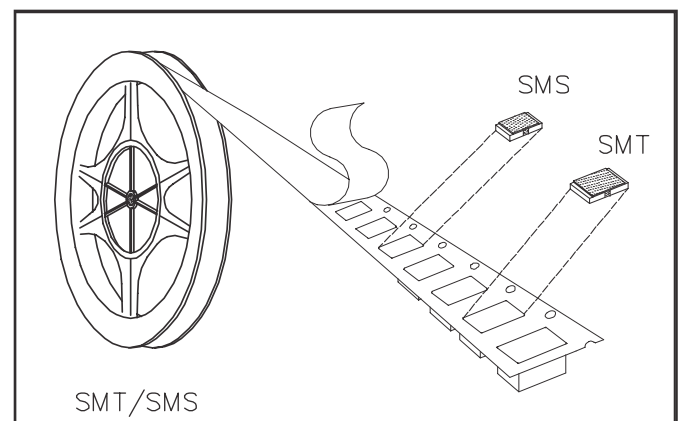

Warranty

All information regarding the suitability, workability and applicability of our products, all technical advice and other information are provided to the best of our knowledge and belief, but shall not discharge the buyer from his own examinations and tests.

Maximum pulse energy respectively pulse power for continuous operation

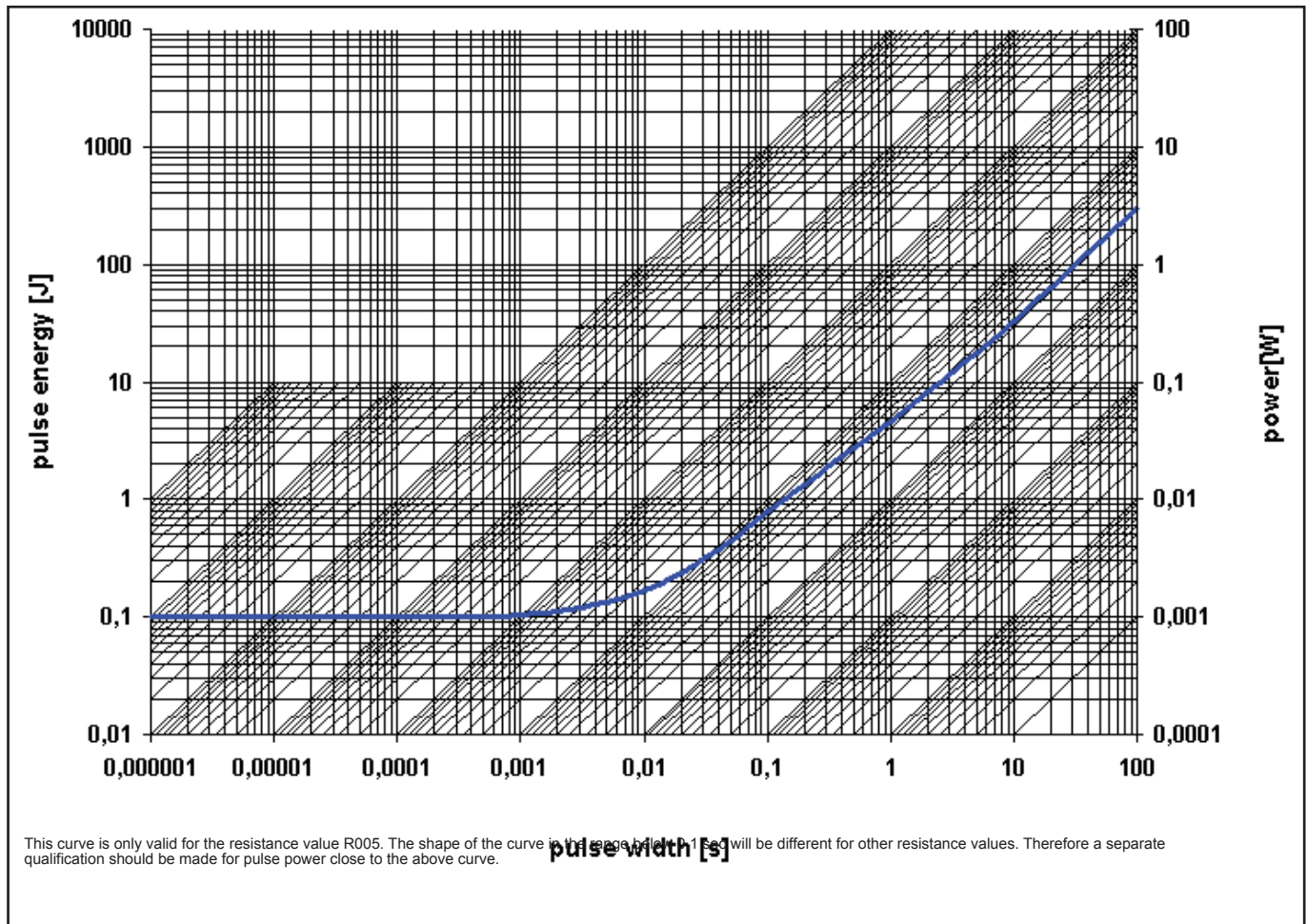

Specification AEC-Q200			
Parameters	Test Conditions	Specification	Typical data
Maximum Temperature for full power operation	95 °C	95 °C	95 °C
Working Temperature	-55 to 170 °C	-55 to 170 °C	-55 to 170 °C
Thermal Shock	MIL-STD-202 method 107-B1	0.1 %	0.1 %
Overload	MIL-R-26E (5 times rated power, 5 sec)	0.2 %	0.2 %
Solderability	MIL-STD-202 method 208	> 95 % coverage	> 95 % coverage
Resistance to Solvents	MIL-STD-202 method 215, 2.1a, 2.1d	no damage	no damage
Low Temperature Storage and Operation	MIL-STD-26E	0.1 %	0.05 %
Resistance to Soldering Heat	MIL-STD-202 method 210	0.1 %	0.05 %
Moisture Resistance	MIL-STD-202 method 106	0.1 %	0.05 %
Shock	MIL-STD-202 method 213-A	0.2 %	0.1 %
Vibration, High Frequency	MIL-STD-202 method 204-B	0.2 %	0.1 %
Life	MIL-STD-26E	0.2 %	0.2 %
Storage Life at Elevated Temperature	MIL-STD-202 method 108-F	0.3 %	0.3 %
High Temperature Exposure	140 °C, 2000 h	0.2 %	0.2%
Current Noise	MIL-STD-202 method 308	0.01 %	0.01 %
Voltage Coefficient (%/V)	MIL-STD-202 method 309	linearity error less than 120dB	linearity error less than 120dB
Resistance Temperature Characteristic	MIL-STD-202 method 304 (20-60°C)	<50 ppm/K	<30 ppm/K
Thermal EMF	0 - 100 °C	2 µV/ K max.	2 µV/ K
Frequency Characteristic R< 25 mOhm	inductivity	< 3 nH	< 1 nH